

Roca

TONIC PREMIUM/TOTAL WHIRLPOOL BATHS

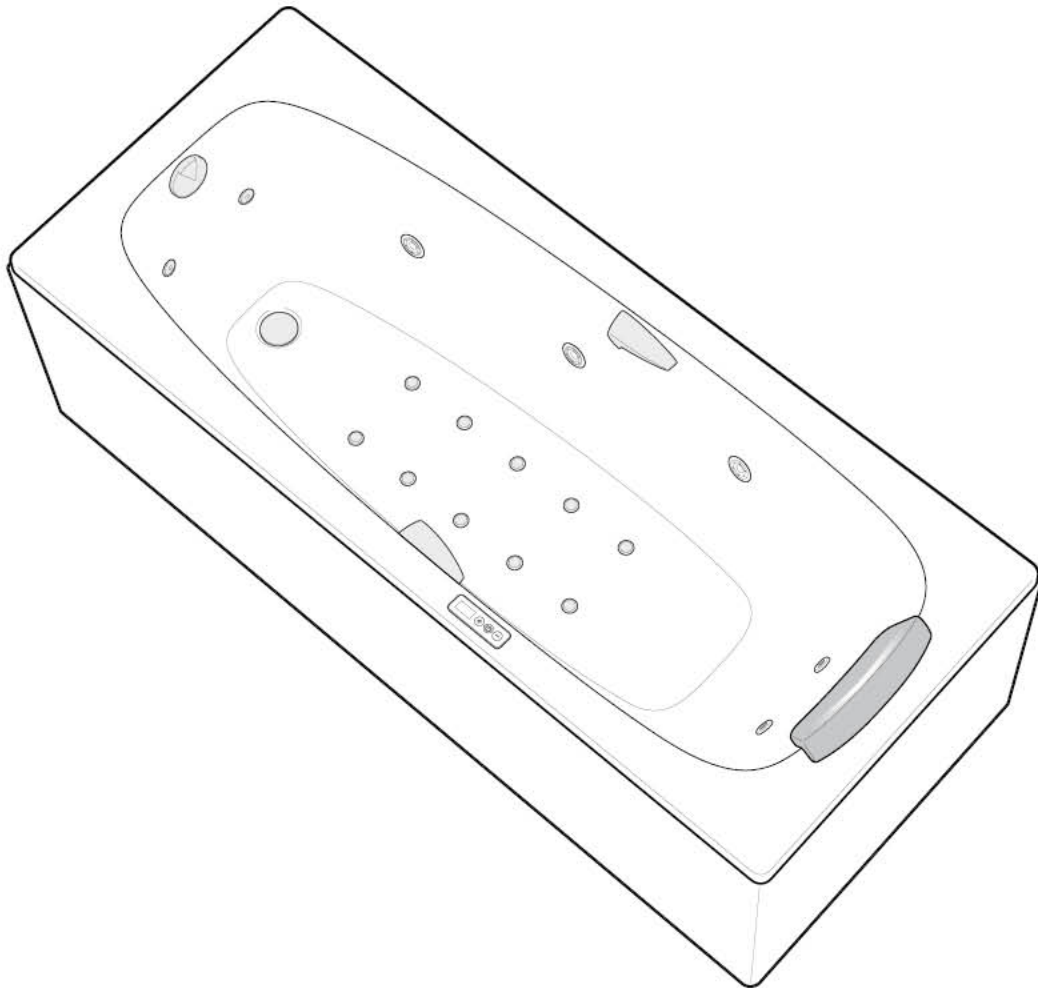

We congratulate you and thank you for purchasing this Roca product, which has been designed, manufactured and checked by our technical staff.

Likewise, if you purchased the panel, it will include specific instructions for installing it.

EFFECTS OF MASSAGE

The action of the air bubbles on the body has been proven to be highly beneficial for the health. The following effects are particularly worth mentioning:

- Stimulates and improves skin hygiene and cardiovascular circulation.
- Generally improves capillary and lymph circulation.
- Tones the muscles and oxygenates the skin.
- Particularly indicated in cases of muscle pain, lumbago, arthritis, post-operative convalescence, stress and fatigue in general.

PRECAUTIONS

- This device is not intended to be used by people (including children) whose physical, sensory or mental capabilities are reduced, or no experience or knowledge, unless they have supervision or instructions concerning the use of the apparatus by a person responsible for security.
- Cleaning and maintenance of this device must not be done by children without supervision.
- Children should be supervised to ensure they do not play with the device.
- In spite of the preventive and relaxing therapeutic effects of hydro-massage, it is important to note that in the case of acute conditions, uncompensated heart disease, serious hypertension or certain infectious diseases, and in the case of certain groups (children, the elderly, and pregnant women), certain special conditions regarding bath duration, temperature and frequency must be borne in mind. In these situations it is advisable to consult your doctor first.
- It is recommended not to take a bath directly after drinking alcohol or having a meal.
- Use only water from your home network properly treated and disinfected.
- If the water hardness of the installation is very high, it is advisable to install a water softener to guarantee that the whirlpool equipment is working properly.
- Do not use foam-bath products with the whirlpool since the amount of foam produced could lead to overflows.

INSTALLATION AND MAINTENANCE

- To guarantee the safety of use of this product, it should only be installed and repaired by qualified installers, who can demonstrate to the appropriate authorities awareness and competence in the application of National Regulatory requirements for safety, i.e. electrical and water supply/disposal.

Index	3
Control panel	4
Keypad	4
Screen	4
Jets	4
Basic functions	5
Stand By	5
On	5
Lack of water	5
Temperature alarm	5
Main menu	6
Water massage	7
Continuous water massage	7
Pulsating water massage	7
Air massage (only Total model)	7
Continuous air massage	7
Pulsating air massage	7

Timer	8
Final blowing	8
Manual blowing	8
Automatic blowing	8

Advanced functions 9

Programs	9
Save program	9
Select program	9



Tutorial mode	10
----------------------	-----------

Troubleshooting 10

Maintenance 11

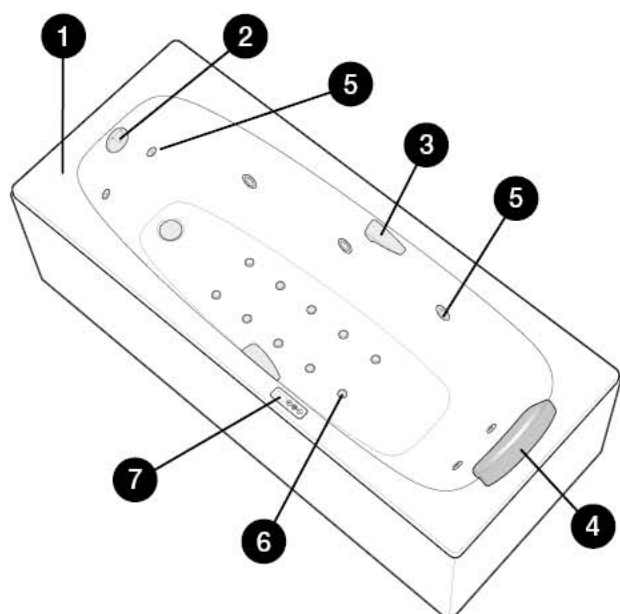
Disposal of electric and electronic products 12



	 A Tonic Premium	 B Total
1 Acrylic bathtub	●	●
2 Waste	●	●
3 Handgrips	*	*
4 Headrests	*	*
5 Water Massage	●	●
6 Air Massage		●
7 Electronic control panel	●	●

* According to model.

Control panel

■ Keypad

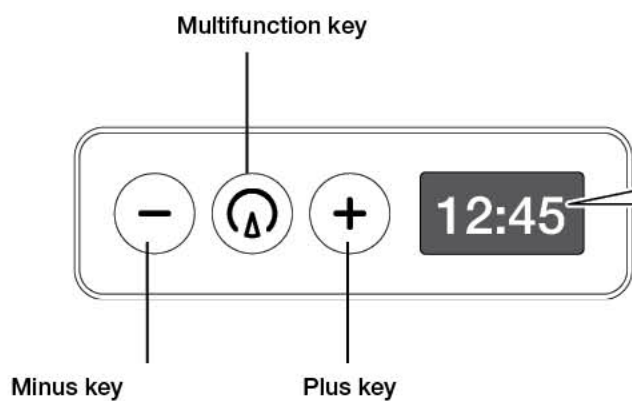

■ Screen

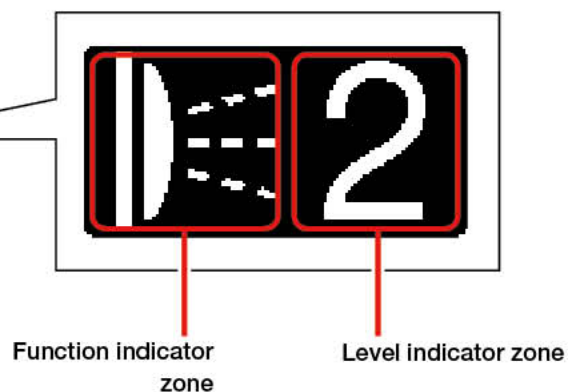

Jets

Position of the jets

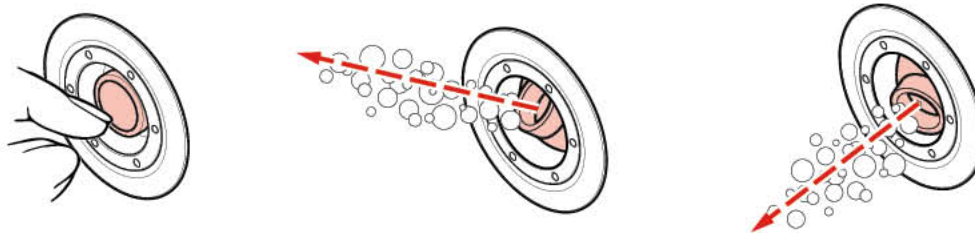

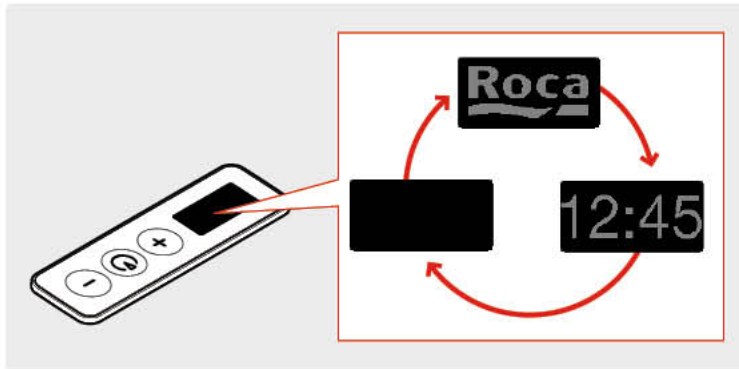

Stand By

It is the default mode of the bathtub when it has not active functions.

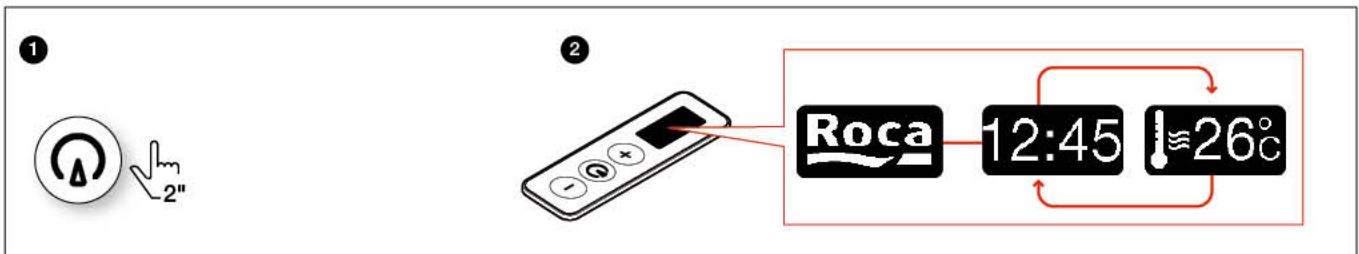

On



If there is not any active functions reverts to Stand by mode, after a minute or press this key  during two seconds.

Lack of water

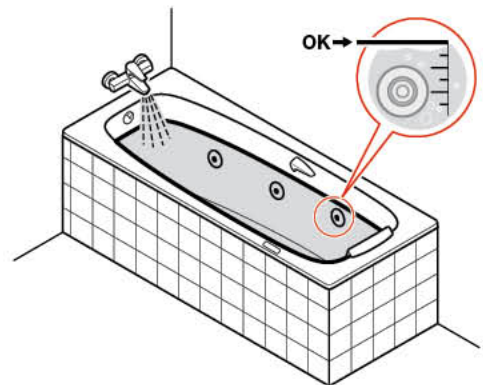

Temperature alarm

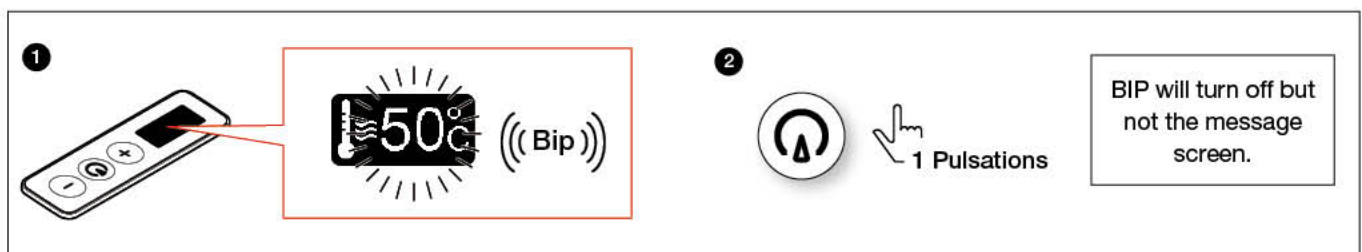

Add cold water for solution.

■ Main menu

Once functions selected, these functions are displayed in the main menu. If the indicated level is "0" the function is not active. The active functions are only displayed on the screen.

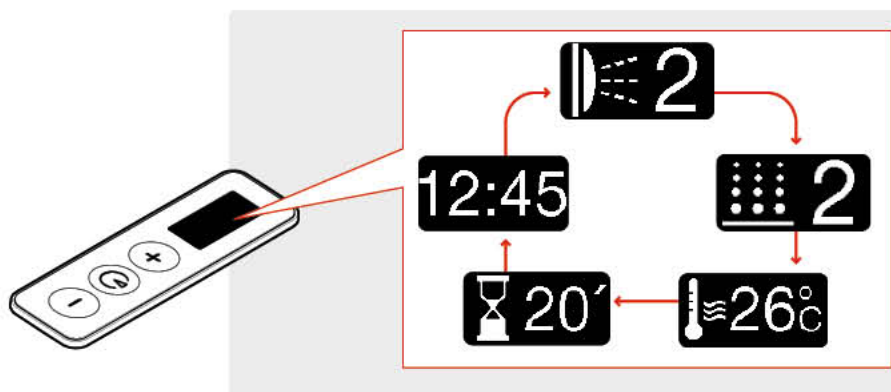

Press this key  during two seconds to stop all functions.

The screen stays on along one minute, during this time it is possible to initiate any function without turning on the bathtub again. If after a minute a function is not selected, the screen returns to stand by mode.

Functions activation sequence:

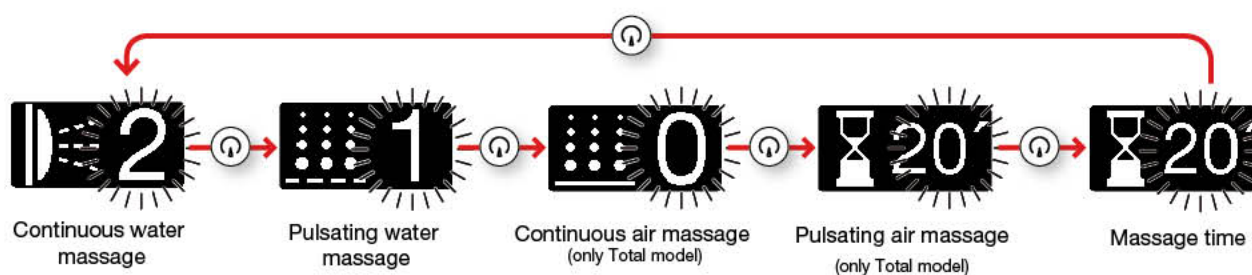

Water massage

During the bath you can enjoy the water massage function, a water massage produced by mixing water and air jets coming out of the bathtub.

Continuous water massage

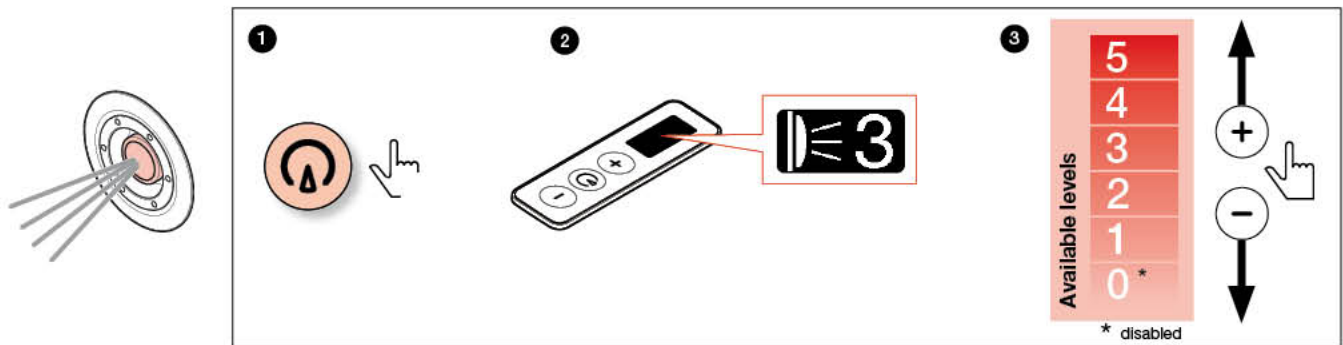

Pulsating water massage

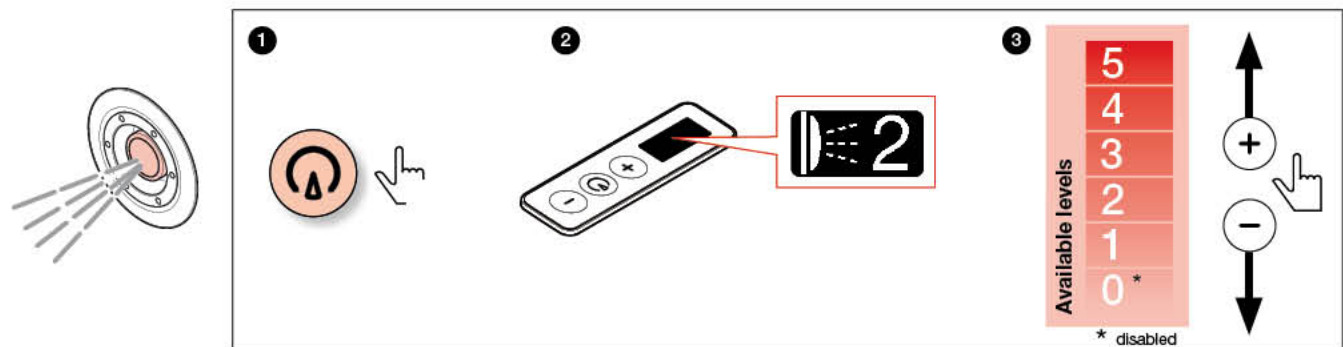

During the bath you can enjoy a massage produced by small air bubbles rising from the holes in the bottom of the bathtub.

Continuous air massage

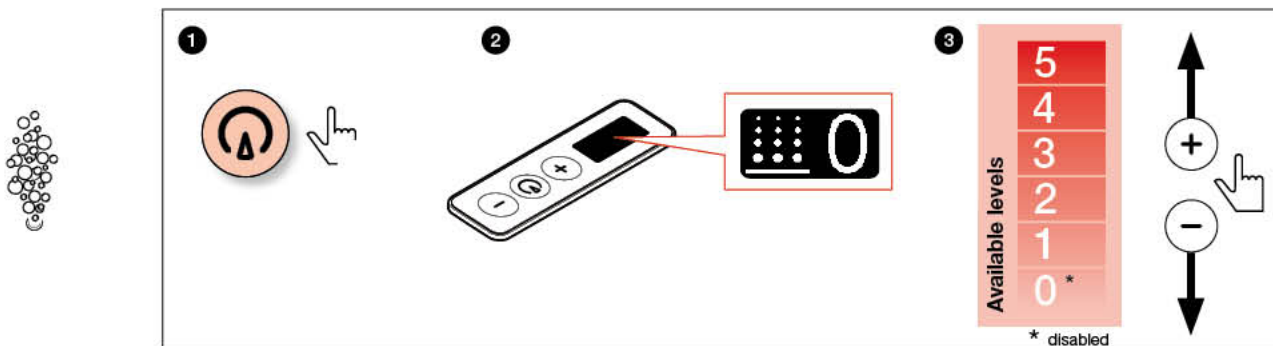

Pulsating air massage

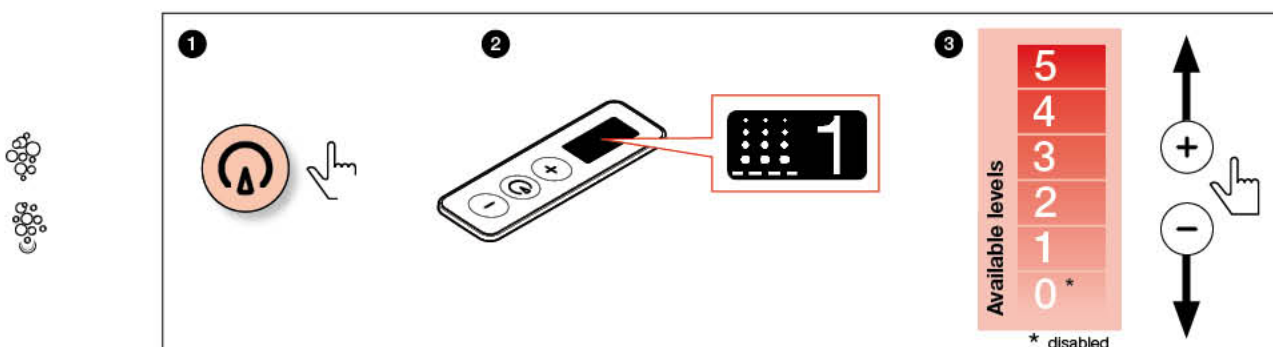

Timer

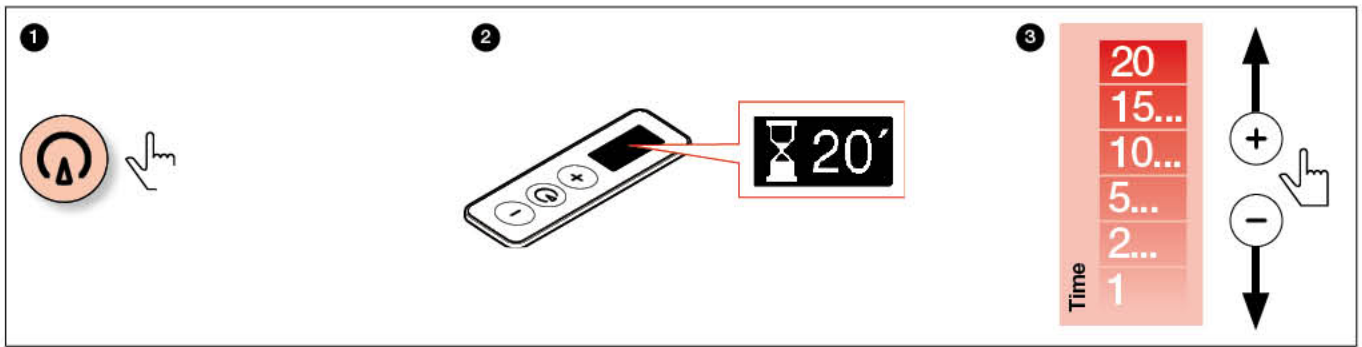

All activate functions come to and end when the message "Time Out" appears intermittently on the screen together with an acoustic signal.

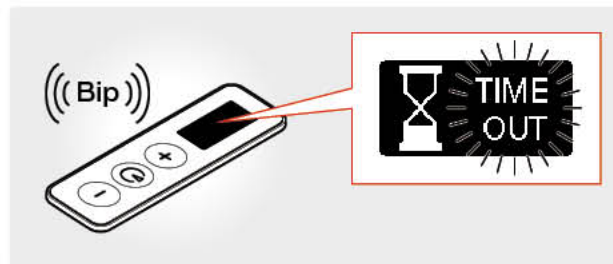

To exit the "Time Out" press this key  or wait 5 " and return to the main menu.

Final blowing

This is the procedure of emptying stagnant water from the air circuit. You must perform this process after every bath / shower, once the bathtub is empty.

Manual blowing

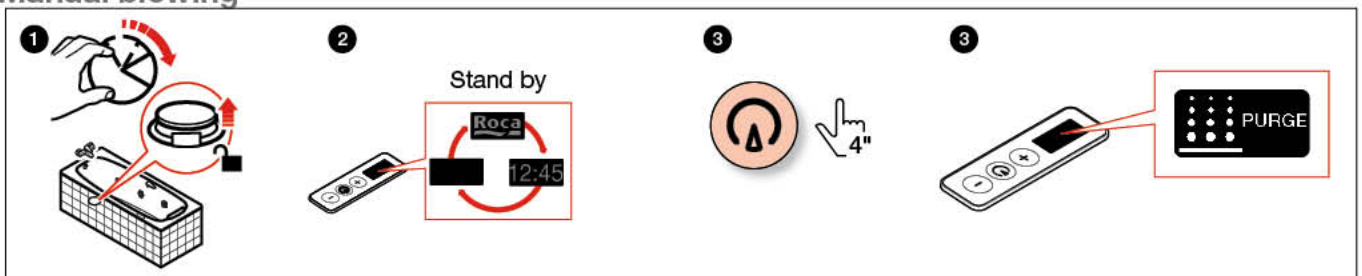

Automatic blowing

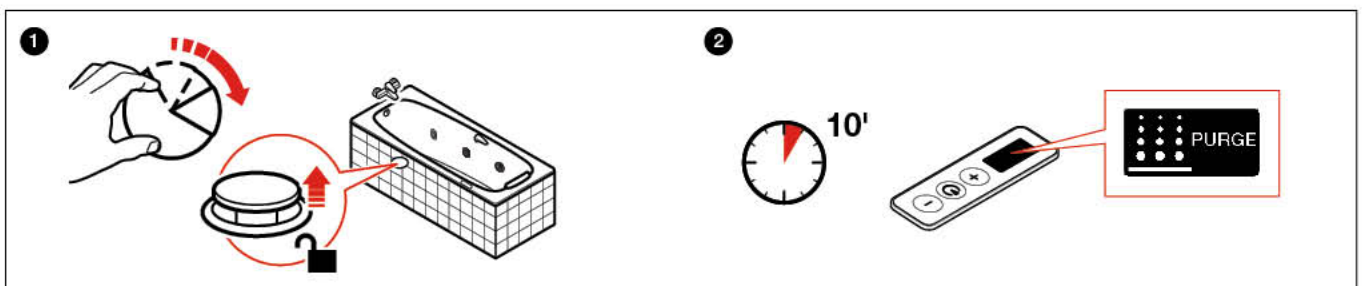

After 10 minutes emptying the bathtub after using the whirlpool, it automatically activates the blowing process, if not previously done manually blowing.

Programs

Save program

The levels of functions selected are saved.

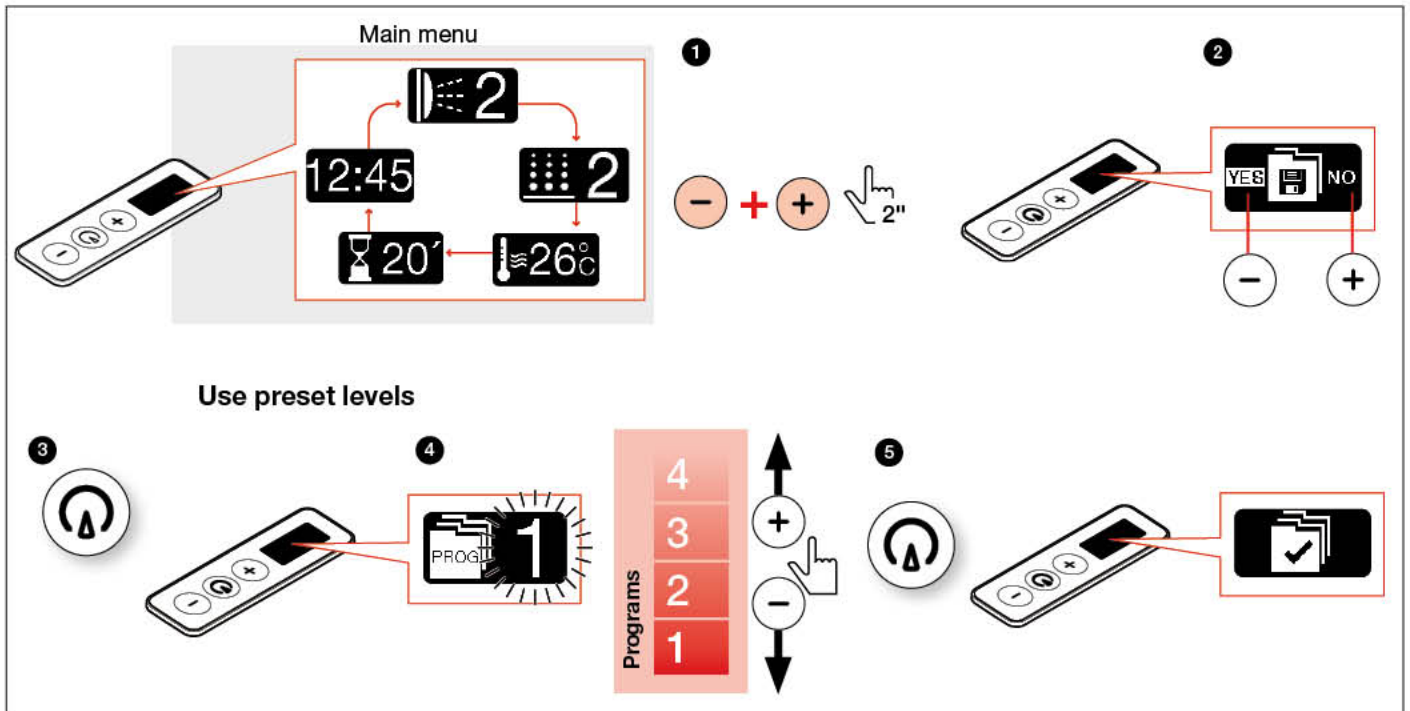

Select program

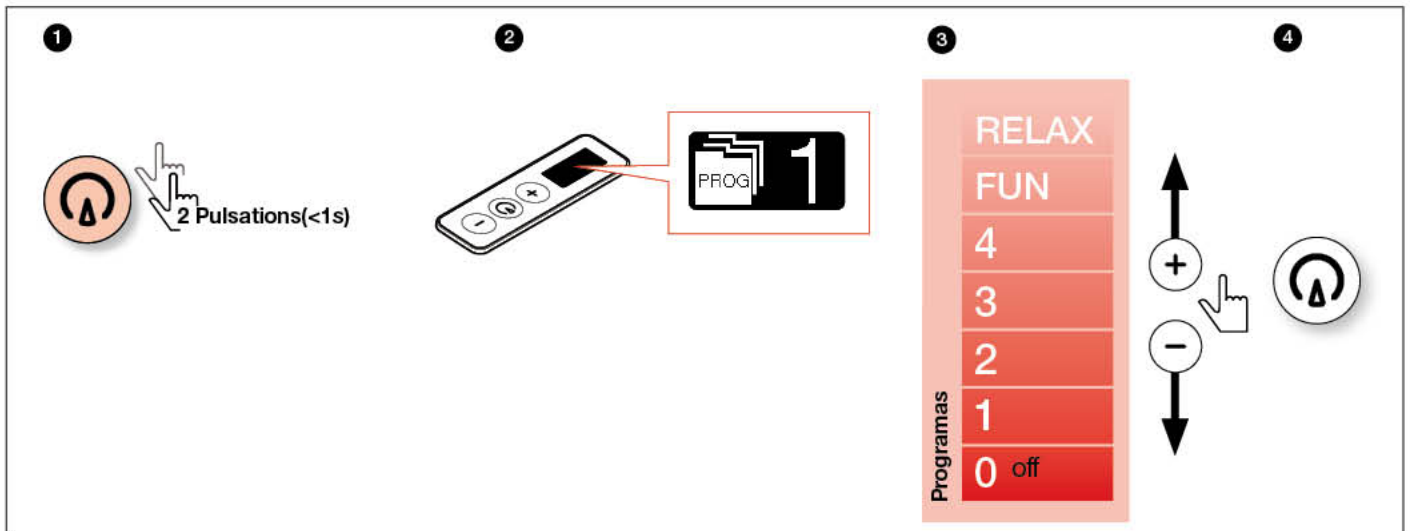

Configuration

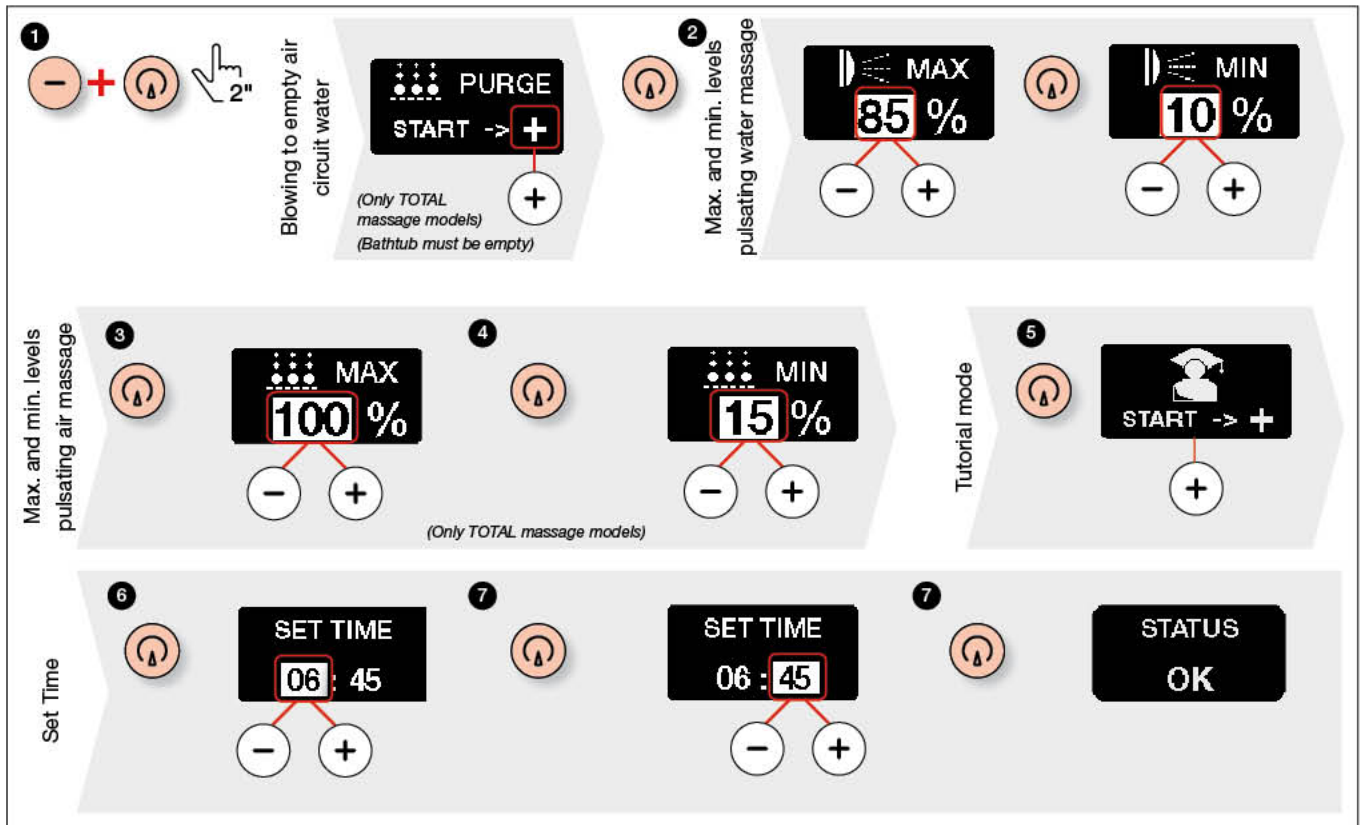

It returns to main screen if you do not press any key during ten seconds or press the key during two seconds.

Tutorial mode



It is the demo mode which sequentially activates all functions of the bathtub.

You can interrupt the tutorial mode in any time by pressing this key during two seconds.

Troubleshooting



Problem	Possible cause	What to do
The screen does not light.	Failure in electricity supply. Magnetothermal switch has cut out.	Check mains supply voltage. Set them to circuit closed position (ON). If they cut out again, contact the Roca Technical Service.
None of the functions switches on.	Insufficient water in the bathtub.	Fill the bathtub.

If the detected anomaly is not resolved with this information, please contact the Roca Technical Service.

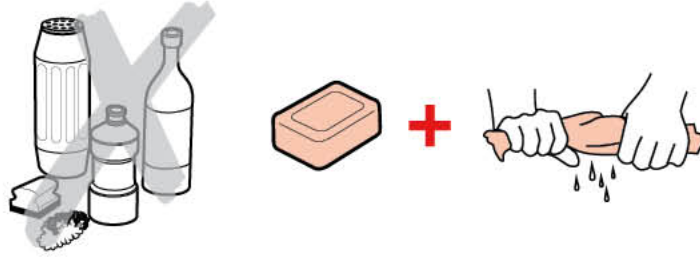

		1	2	3	4	5
6	7	8	9	10	11	12
13	14	15	16	17	18	19
20	21	22	23	24	25	26
27	28	29	30			

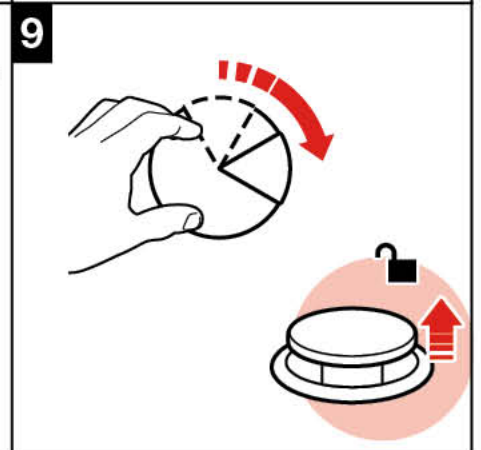
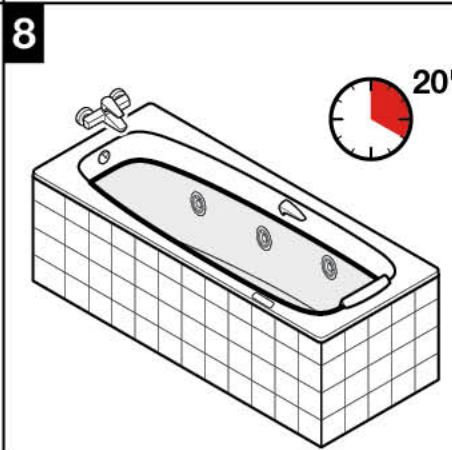
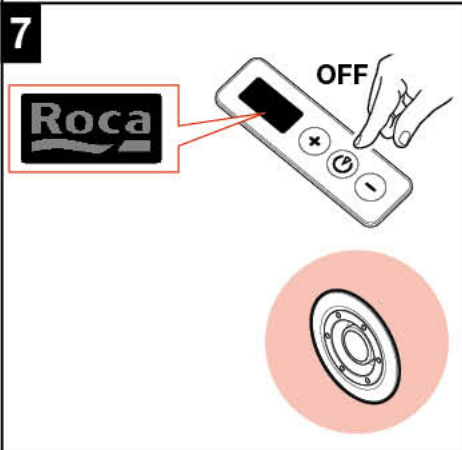
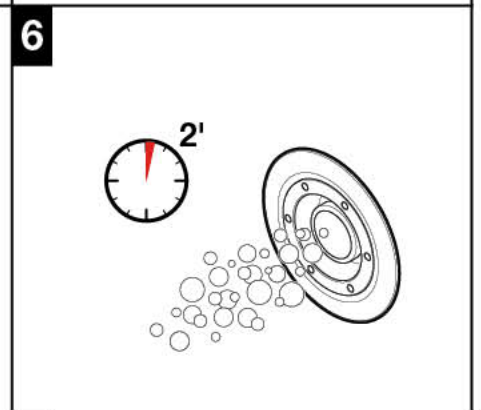
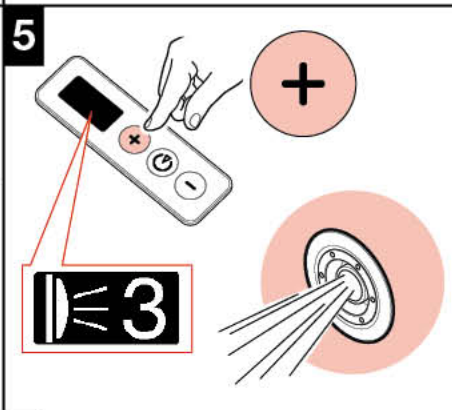
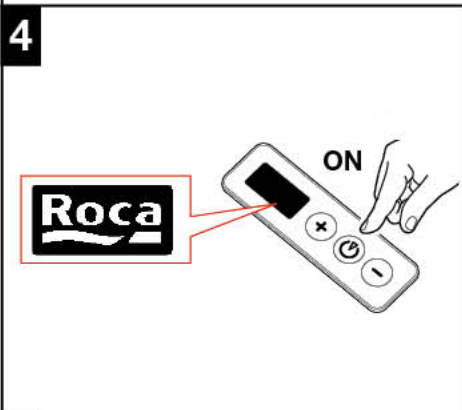
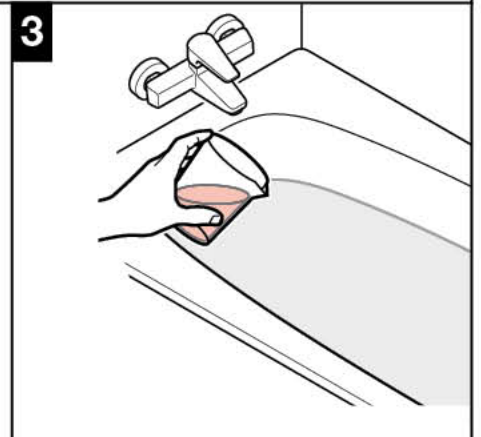
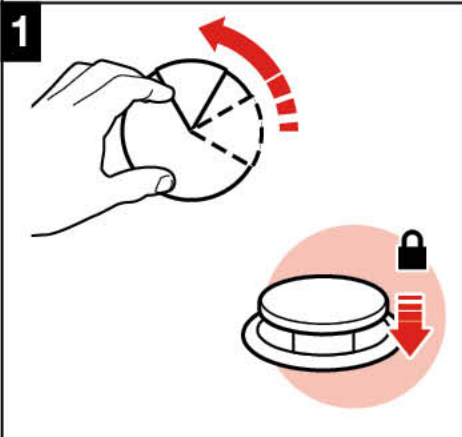
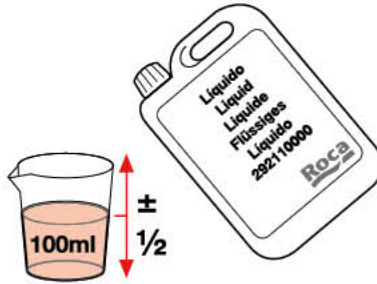

Disposal of electric and electronic products



NOTE: This symbol and recycling system is only applicable in the European Union. It does NOT apply to the rest of the world.

At ROCA we are committed to protecting the environment. Please help us by discarding this product at the end of its life-cycle in a responsible manner, to prevent that certain substances contained in electrical or electronic equipment may cause harm to human health and the environment.

The crossed-out wheeled bin symbol, shown above and on the product, means that it should not be discarded with other household waste. At the end of the product's life-cycle, it must be delivered to the corresponding collection facilities enabled by the authorities in your country or to the supplier from which you purchase a product of equivalent type or that fulfills the same functions as the previous equipment. This last option may not be available in some countries, so please check with the authorities in your country about the collection systems available and the collection facility closest to your home.

This way, you can cooperate with the protection of the environment through the reuse and recycling of waste electrical and electronic equipment. On the contrary, administrative responsibilities can be derived for you in case of non-compliance with the rules for the delivery of the waste of this product.



Roca Sanitario, S.A.
Avda. Diagonal, 513
08029 Barcelona
SPAIN
www.roca.com

933
661
266 | LÍNEA DE ATENCIÓN
AL CONSUMIDOR
ESPAÑA 
SERVICIO TÉCNICO
ESPAÑA 



productsupport.rs@roca.net
soporteproducto.rs@roca.net