

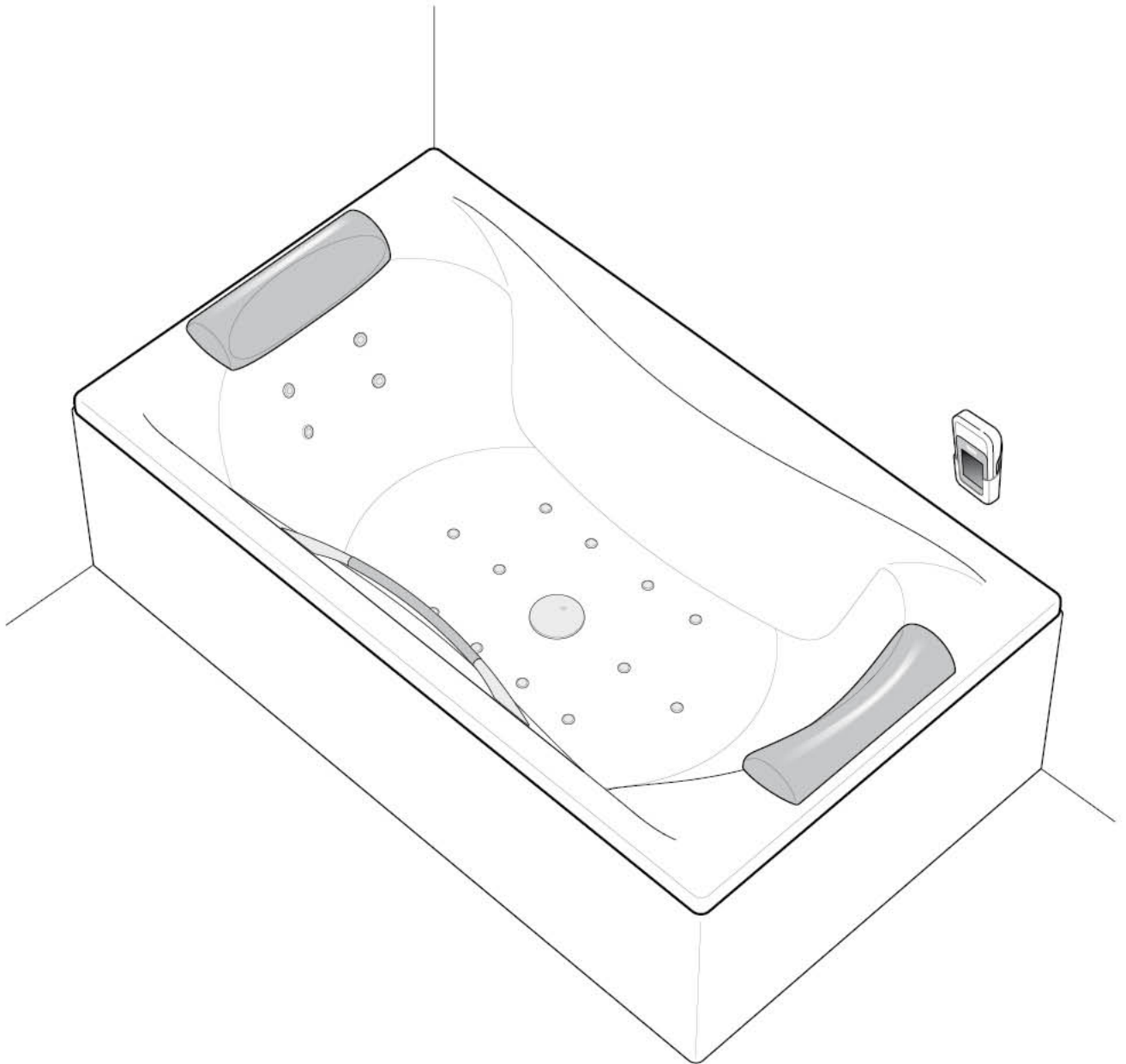

Roca

TOTAL PREMIUM



We congratulate you and thank you for purchasing this Roca product, which has been designed, manufactured and checked by our technical staff.

Likewise, if you purchased the panel, it will include specific instructions for installing it.

EFFECTS OF MASSAGE

The action of the air bubbles on the body has been proven to be highly beneficial for the health. The following effects are particularly worth mentioning:

- Stimulates and improves skin hygiene and cardiovascular circulation.
- Generally improves capillary and lymph circulation.
- Tones the muscles and oxygenates the skin.
- Particularly indicated in cases of muscle pain, lumbago, arthritis, post-operative convalescence, stress and fatigue in general.

PRECAUTIONS

- This device is not intended to be used by people (including children) whose physical, sensory or mental capabilities are reduced, or no experience or knowledge, unless they have supervision or instructions concerning the use of the apparatus by a person responsible for security.
- Cleaning and maintenance of this device must not be done by children without supervision.
- Children should be supervised to ensure they do not play with the device.
- In spite of the preventive and relaxing therapeutic effects of hydro-massage, it is important to note that in the case of acute conditions, uncompensated heart disease, serious hypertension or certain infectious diseases, and in the case of certain groups (children, the elderly, and pregnant women), certain special conditions regarding bath duration, temperature and frequency must be borne in mind. In these situations it is advisable to consult your doctor first.
- It is recommended not to take a bath directly after drinking alcohol or having a meal.
- Use only water from your home network properly treated and disinfected.
- If the water hardness of the installation is very high, it is advisable to install a water softener to guarantee that the whirlpool equipment is working properly.
- Do not use foam-bath products with the whirlpool since the amount of foam produced could lead to overflows.

INSTALLATION AND MAINTENANCE

- To guarantee the safety of use of this product, it should only be installed and repaired by qualified installers, who can demonstrate to the appropriate authorities awareness and competence in the application of National Regulatory requirements for safety, i.e. electrical and water supply/disposal.

Contents	3	Chromotherapy	8
Description	4	■ Selection of predefined colors and cycles	8
■ Whirlpool bathtub	4	Other functions	9
■ Remote control	4	■ Temperature maintenance	9
Main screens	4	■ Timer	9
Adjustment screen	4	■ Programs	10
Basic functions	5	Save new programs	10
■ Direct activation of functions	5	■ Ozone disinfection	11
■ Power selection screen / options	5	■ Tools	12
■ Lack of water	5	Final blowing	12
■ Water temperature alarm	5	Demo Mode	12
Hydromassage functions	6	Restore	13
■ Water massage	6	Synchronization	13
■ Soft massage (water+air)	6	Status	13
■ Air massage	7	Troubleshooting	14
■ Pulsating air massage	7	Maintenance	15
		Disposal of electric and electronic products	16

Description

Whirlpool bathtub

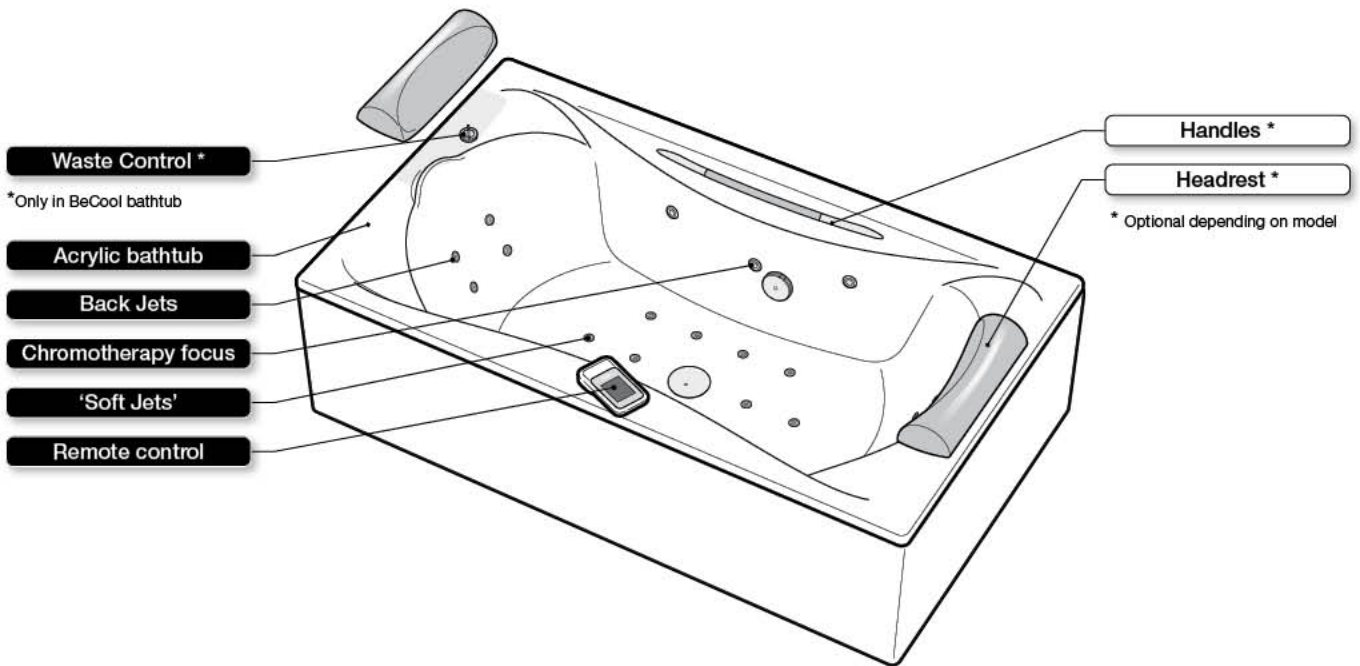

Remote control

The unit has a remote control with color touch screen that can be used inside and outside the bathtub to control the hydromassage functions.

The screen changes to power saving mode after 10 seconds without pulsation. To activate it again, you should press 1 time in any part of the screen.



⚠ It is required to place the batteries to use the remote control (see pg. 15)

It is necessary to synchronize the remote control with the bathtub before first use. (see pg. 13)

Main screens

Main menu			
1	26°C 15'	2	1 Water temperature
3	WATER WATER + AIR	4	2 Remaining time
5	AIR AIR PULSE	6	3 Water massage
7	CHROMO	8	4 Soft massage (water+air) [⊞]
			5 Air massage [⊞]
			6 Pulsating air massage [⊞]
			7 Chromotherapy [⊞]
			8 Next menu

Other functions			
1	26°C H P 15'	2	1 Temperature maintenance ON indicator
3	HEATER TIMER	4	2 Programa ON indicator
5	PROGRAMS OZONE	6	3 Temperature maintenance
7	TOOLS	8	4 Timer [⊞]
			5 Programs [⊞]
			6 Ozone disinfection
			7 Tools [⊞]
			8 Previous menu

[⊞] = level adjustment
[⊞] = submenu

Adjustment screen

1	[Sun icon]	2	1 Function selected
3	[Decrease button]	4	2 Level indicator
	[Increase button]		3 Decrease
	[Previous button]		4 Increase
			5 Previous Menu

Direct activation of functions

Function is enabled in the default level.

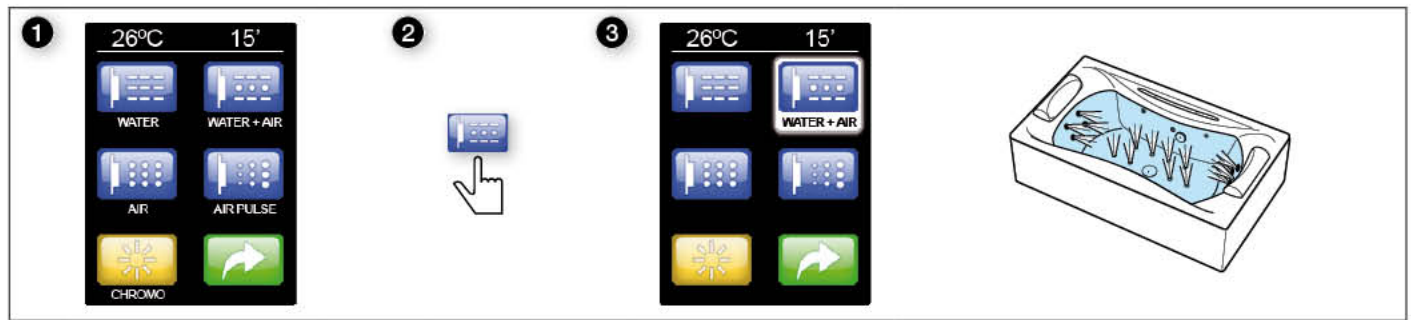

Power selection screen / options

Level selection to increase or decrease the intensity / options value. If the value set is "0", the function stops.



Lack of water

When the water level in the bathtub is not enough, it does not start to work or functions in progress are stopped. Also, the remote control warns about lack of water along with an acoustic signal.

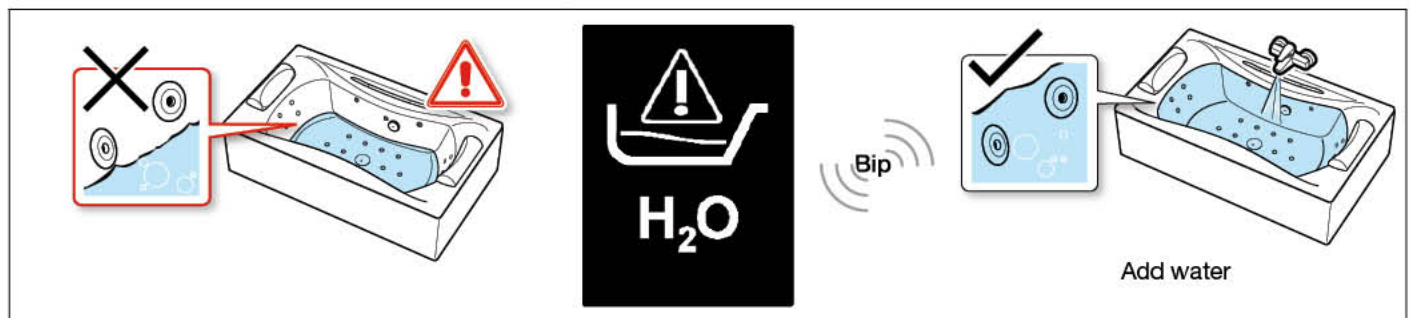

Water Temperature alarm

If the water temperature is 50°C or more, an acoustic signal is activated and the functions in progress are interrupted.



Hydromassage functions

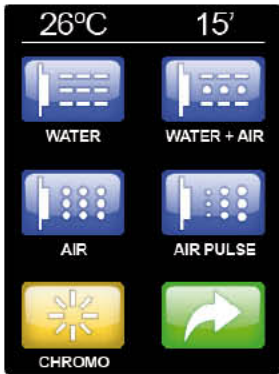

Water massage

The water massage is made by water jets that produce a stimulating effect on our body. In Total Premium bathtubs, water massage consists of a dorsal and plantar massage with jets especially suitable for sensitive areas of the body.



Soft Massage (water+air)

Total massage session: massage that combines the effect of air and water, an integrated experience for an embracing effect perfect to relax your body and your mind. It is a very soft effect and more relaxing than the air massage. This massage is produced through Soft jets that create a Champagne effect.



Air massage

The air massage, is a massage in the form of bubbles that are ejected through small jets at the bottom of the bathtub, obtaining a relaxing massage by the embracing effect of bubbles.



Pulsating air massage

The pulsating air massage increases and decreases its intensity periodically.

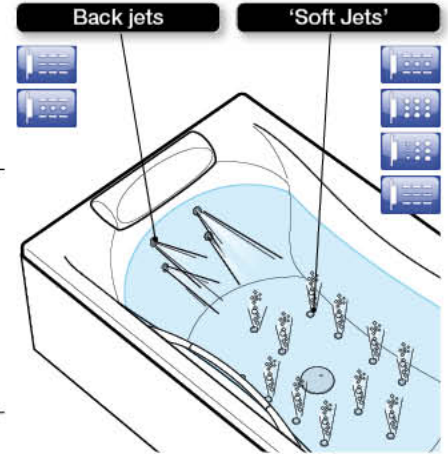

Water massage

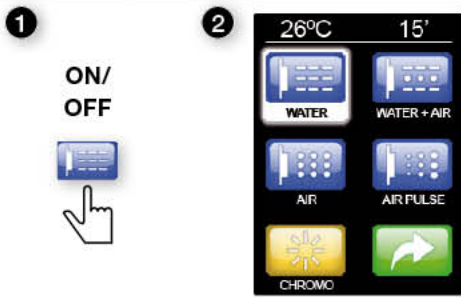
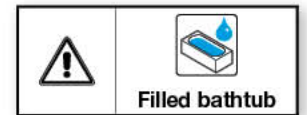

It is not possible to adjust the level of this function.

Soft massage (water+air)

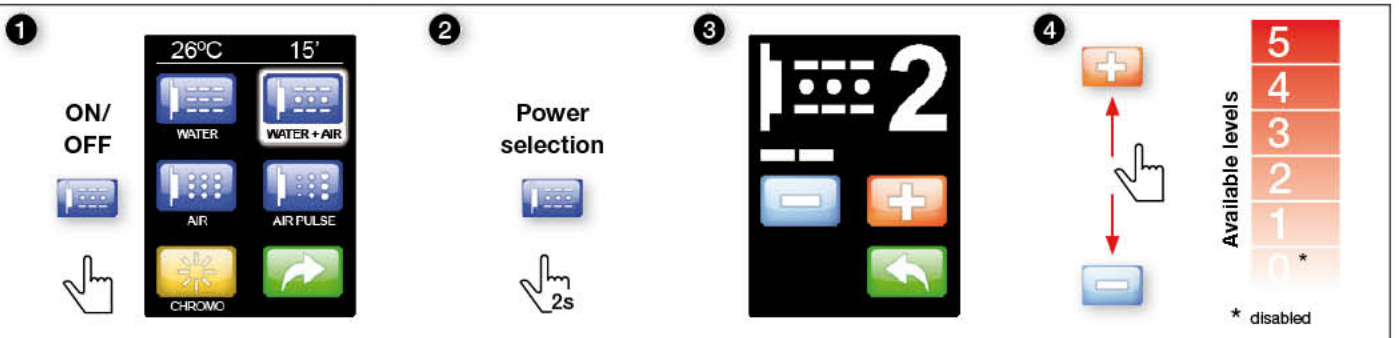
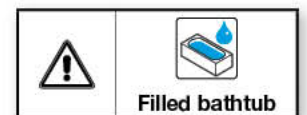

Air massage

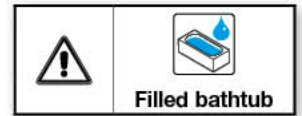

- 1 **ON/OFF**
- 2
- 3 **Power selection**
- 4
- 4

Available levels

* disabled

Pulsating air massage

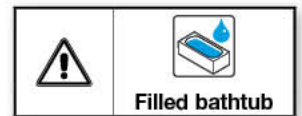

- 1 **ON/OFF**
- 2
- 3 **Selection of the duration of the period**
- 4
- 5

Available levels

* disabled

Chromotherapy

In Total Premium, you will find the Chromotherapy function. This function is performed through 3 LED lights that change their color to create an embracing effect that perfectly fits in with the hydromassage session.

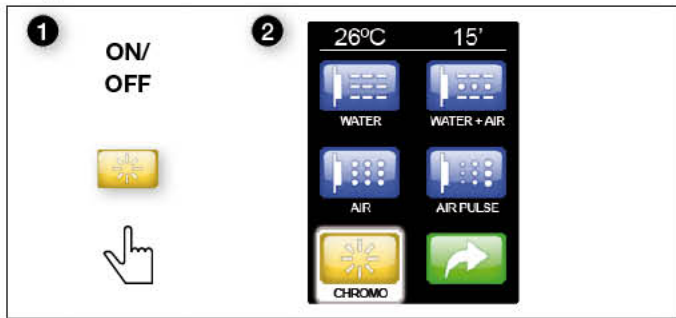
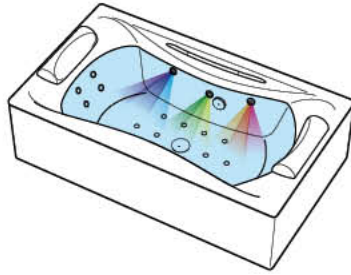

Colours meaning and use		
1	White	Represents purity and the light of day. Feeling of warmth and transparency.
2	Red	Primary colour warm, stimulating in distress and physical states of weakness in the body.
3	Blue	Primary colour cold temperament. It has sedative and tranquilizing effect.
4	Yellow	Synonym of light. It brings optimism, vitality, joy and enthusiasm for life.
5	Green	It has effects on the mental balance, reassuring. Not for nothing is the colour of nature.
	Cycle 'Soft'	Cycle energizing, warm colours and stimulating.
	Cycle 'Live'	Sequence of soft colours with a relaxing effect.

Selection of predefined colors and cycles

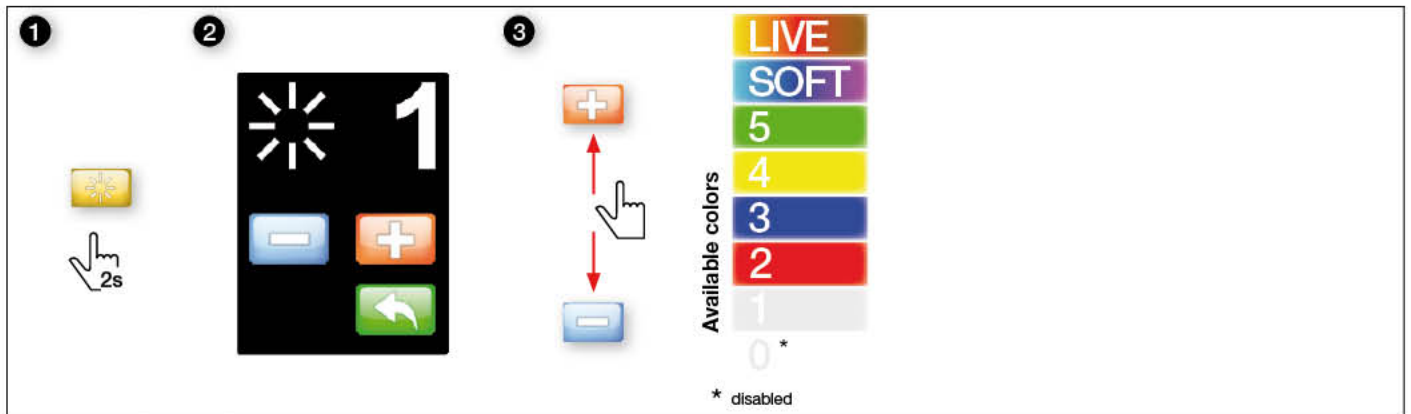

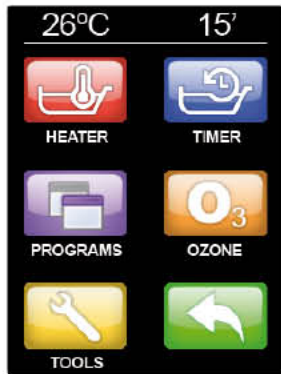

Temperature maintenance

Constant water temperature during the massage.



Timer

Change the duration of the massage between 1 and 30 minutes. The default is 20 minutes.



Programs

The system allows the customization of the massage session, being able to create programs according to the needs and desires of each user by a simple and fast way, or select preset programs.



Ozone disinfection

Ozone in small amounts produces a sanitizing effect throughout the whole hydromassage system, maintaining a clean system every time you use it.



Tools

Options and configuration settings.

Temperature maintenance

1 ON/OFF

2

ON/OFF (single level).
Compatible only with whirlpool Water and Water+Air.
Maintain the temperature of the water that exists at the moment of the activation.

**WATER
massage
is OFF**

! The function will not start if the water massage or soft massage is not activated.

Timer

1 ON/OFF

2

3

4

Bip
Bip
Bip

**Time
Out**



End of hydromassage



Whirlpool time setting



Programs





1 



2 

Program 1  Ultra soft relaxing program that combines a soft hydromassage air  with a chromotherapy session  with a sequence of basic colors that alternate every 30 seconds.
⌚ 15min.

Program 2  Soft program with a comforting session of bubbles  at low level and chromotherapy  with color changes every 10 seconds.
⌚ 10min.

Program 3  Relaxing program that includes a varying levels of bubbles  massage simultaneously with a chromotherapy session  in SOFT mode.
⌚ 10min.

Program 4  Stimulating program that combines a quick sequence of whirlpools of water , air  and bubbles  massages with chromotherapy session  with color changes synchronized with the changes of massage.
⌚ 5min.

Program 5  Tonic program consists of the combination of water massage  with pulsating air  at maximum level and a session of chromotherapy in LIVE mode.
⌚ 5min.

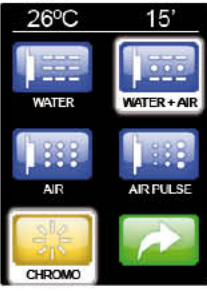

Save new programs

1 

(example)

2 

3 

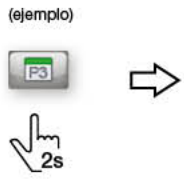
4 

(ejemplo)

Select the type of massage, power and the desired duration, as well as the color or cycle colors of chromotherapy.

Select any of the numbers available to save the new program.

 The new program will replace the previous one.

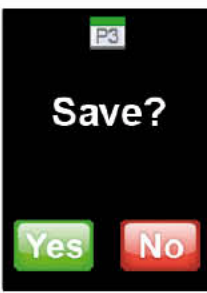
5 

(example)

6 

7 

The selection of customized hydromassage will be save in the selected program.

Ozone disinfection

	Filled bathtub	Disabled functions
--	----------------	--------------------

AUTOMATIC MODE

- Select the automatic mode before or during the hydromassage. The setting is saved for future sessions.
- Start** **Auto**
- AUTOMATIC MODE ENABLED**
 End hydromassage
- Active clean system?**
Yes **No**
"YES": the function is activated. The function is also automatically activated after 30 seconds. If you want to cancel automatic disinfection, click "NO".
- Clean system active**
12' Remaining time
Total process: 30min.
- Exit the bathtub**
10 seg.
Bip
- End of the process.**
The main screen is displayed (If the remote control is active)

MANUAL MODE

- End hydromassage
- Select the manual mode after the hydromassage.
- Active clean system?**
Yes **No**
- Exit the bathtub**
10 seg.
Bip
- Clean system active**
12' Remaining time
Total process: 30min.
- End of the process.**
The main screen is displayed (If the remote control is active)

Tools

	 PURGE	 DEMO MODE	 Final blowing	<p>This is the procedure of emptying stagnant water from the air circuit after the massage.</p>
	 RESET	 SYNCHRO	 Demo mode	<p>It performs a demonstration cycle of the functions of the equipment.</p>
	 STATUS	 RESTORE	 Restore	<p>The default values of all functions and programs are restored.</p>
			 Synchronization	<p>Synchronize the remote control with the bathtub. It is only necessary to synchronize before the first use.</p>
			 Status	<p>Help function for technical service. It allows checking the status of the electronic components of the equipment.</p>

Final blowing

	Empty bathtub	Disabled functions

AUTOMATIC MODE	1				 The blowing process is activated automatically within finishing the hydromassage and between 30 minutes after; and unless the manual blowing process has been activated before.
	2				
	3				
				15-30s	

MANUAL MODE	1				 Blowing is started immediately.	
	2					 It will not run if there is water in the bathtub.
	3					
	4					

Demo Mode

	Filled bathtub

1	2	3
	1' 30"	

Restore



Synchronization

 Synchronization is possible only before the first minute, after connecting the bathtub to the power supply.

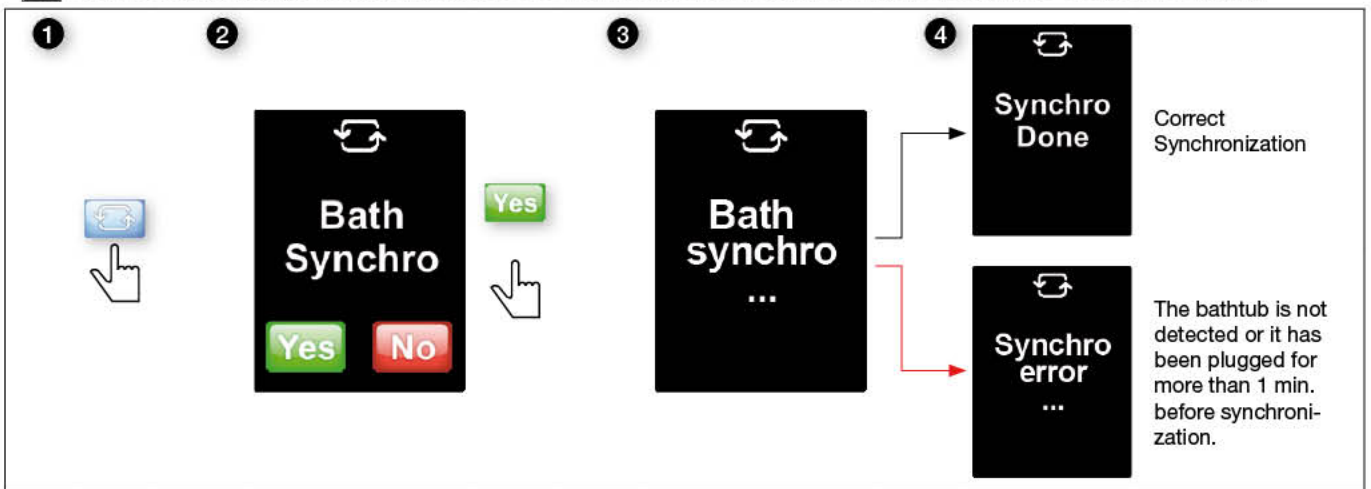

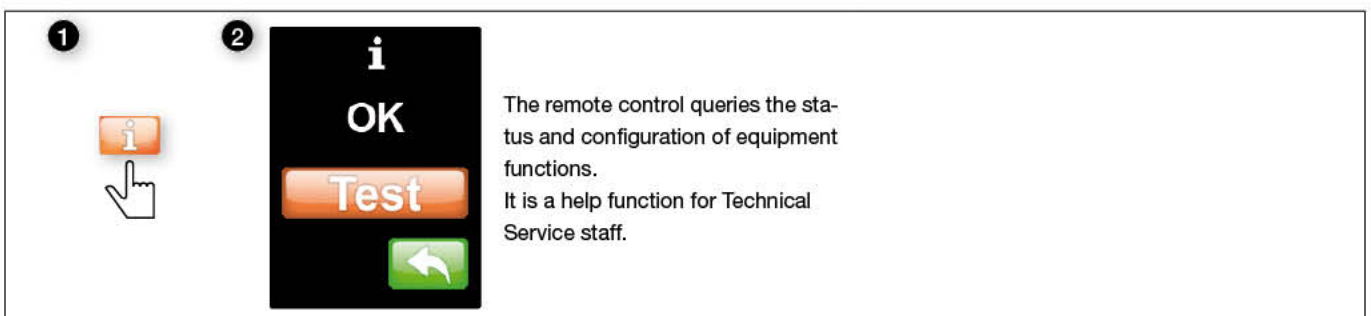

Status



Troubleshooting



Problem	Possible cause	Solution
The remote control screen will not turn on	Power supply failure in the remote control.	Change the remote control batteries with new ones
Dashes appear in the remote control instead of the numbers of temperature and / or hydromassage time	Power supply failure in the bathtub	Check that there is tension in the power supply
	Magnetothermal switch has been tripped	Place it on closed circuit position (ON) If magnetothermal switch trip again, contact Roca Technical Service
	No synchronization with the bathtub	Synchronize it with the bathtub (see pg. 13)
The hydromassage did not start or the active function unexpectedly stops working	There is not enough water in the bathtub	Fill the bathtub
	Water temperature is excessive	Decrease the water temperature
	No water arrives to hydromassage system pump	If your bathtub is equipped with a drain with hydromassage suction, the lid must be placed properly, as shown:  

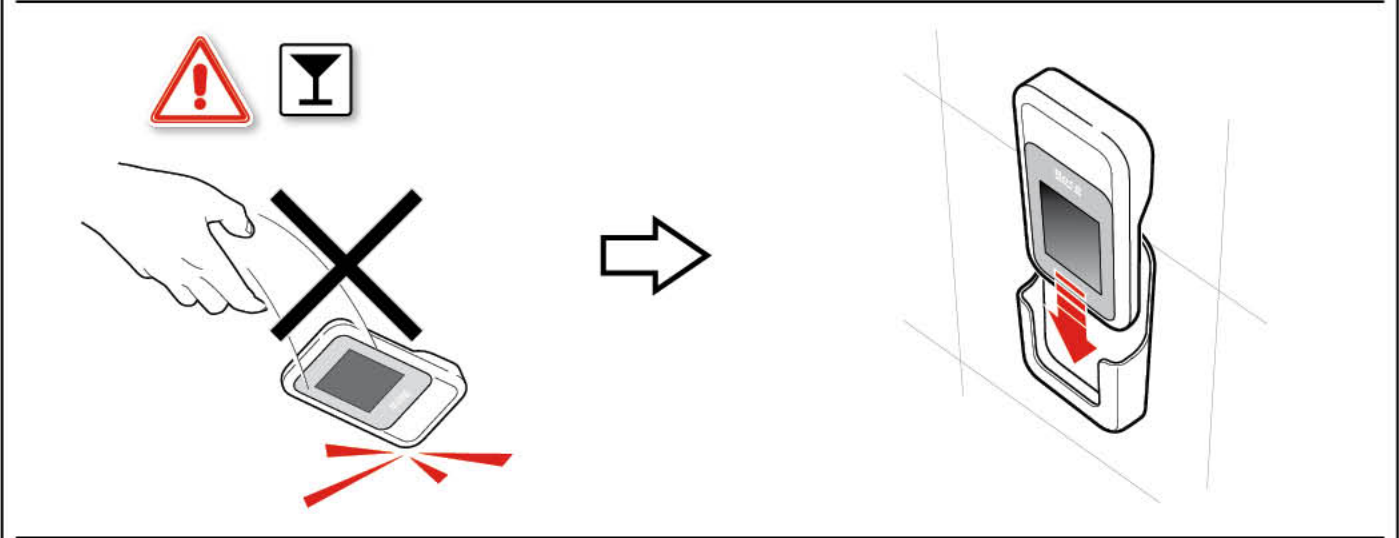
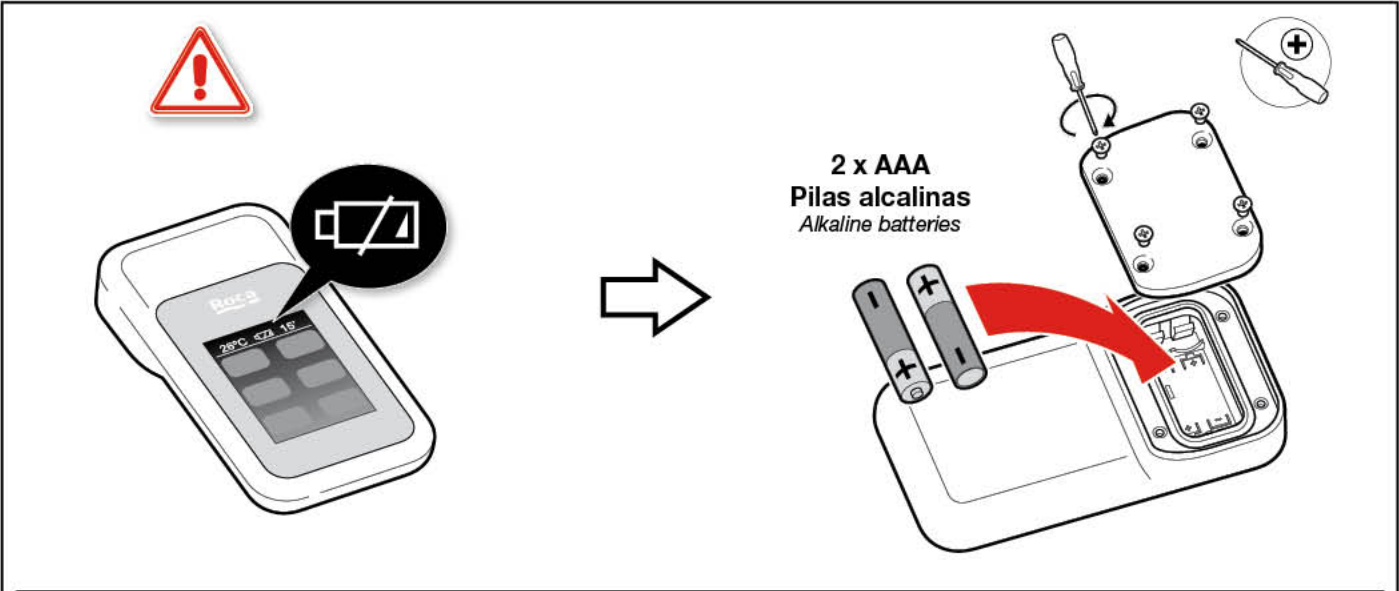
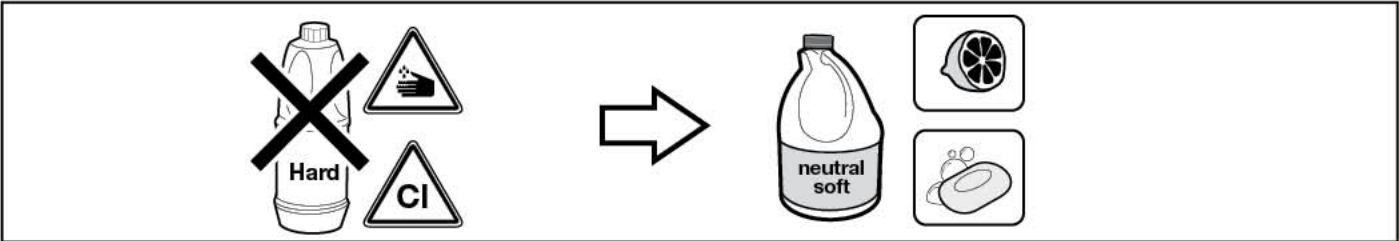

Disposal of electric and electronic products



NOTE: This symbol and recycling system is only applicable in the European Union. It does NOT apply to the rest of the world.

At ROCA we are committed to protecting the environment. Please help us by discarding this product at the end of its life-cycle in a responsible manner, to prevent that certain substances contained in electrical or electronic equipment may cause harm to human health and the environment.

The crossed-out wheeled bin symbol, shown above and on the product, means that it should not be discarded with other household waste. At the end of the product's life-cycle, it must be delivered to the corresponding collection facilities enabled by the authorities in your country or to the supplier from which you purchase a product of equivalent type or that fulfills the same functions as the previous equipment. This last option may not be available in some countries, so please check with the authorities in your country about the collection systems available and the collection facility closest to your home.

This way, you can cooperate with the protection of the environment through the reuse and recycling of waste electrical and electronic equipment. On the contrary, administrative responsibilities can be derived for you in case of non-compliance with the rules for the delivery of the waste of this product.

Batteries shall be previously removed and discarded separately in suitable recycling containers.