

ORAS GROUP
Isometsäntie 2, P.O. Box 40
FI-26101 Rauma
Finland

Tel. +358 2 83 161
Fax +358 2 831 6300
info.finland@oras.com
www.oras.com

943370-02-19

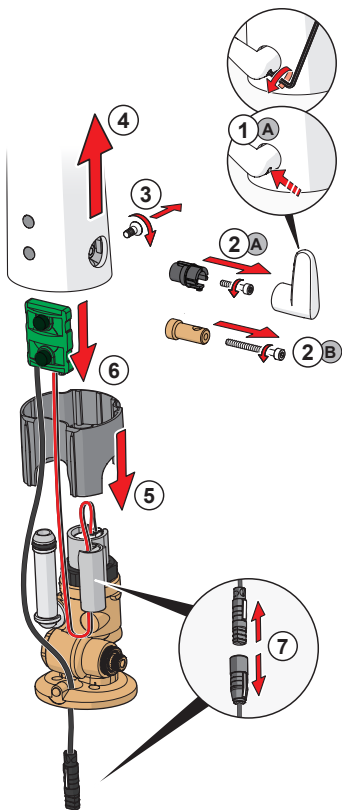

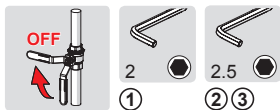
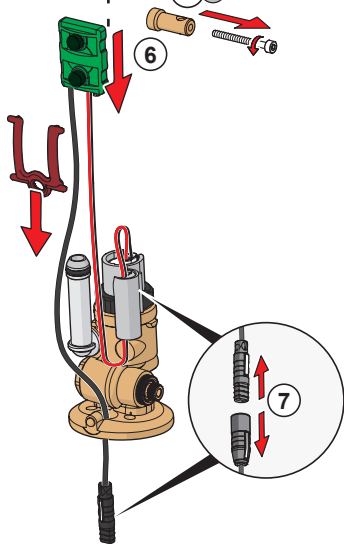
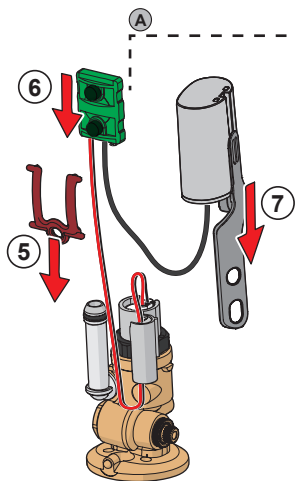
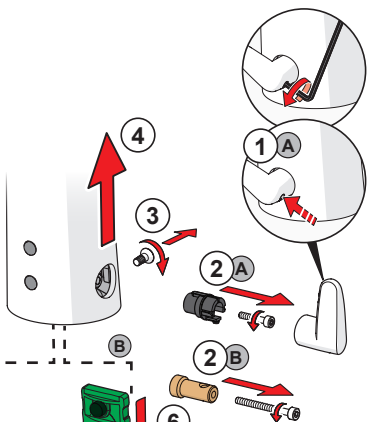
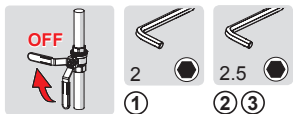

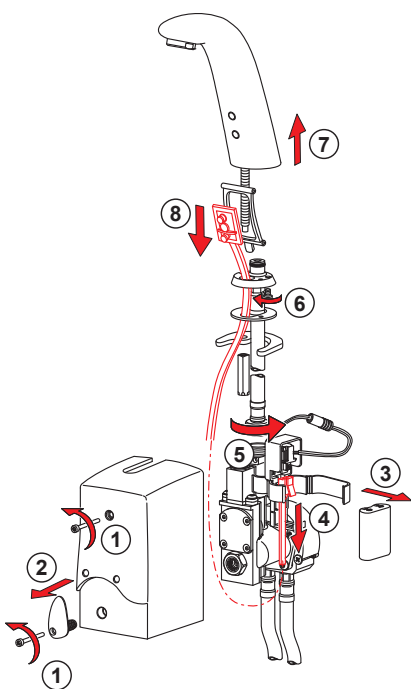
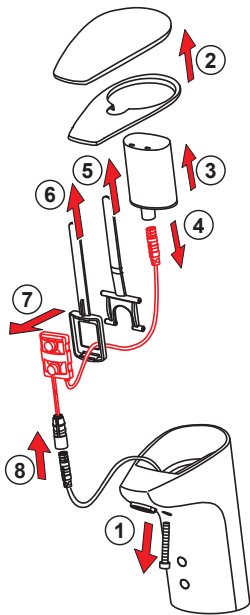
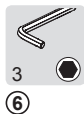
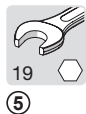
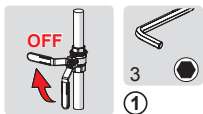

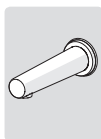
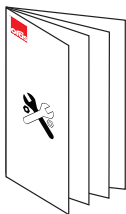

static.oras.com/manual/6188

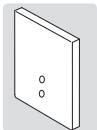

static.oras.com/manual/6507C

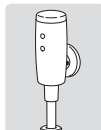

static.oras.com/manual/6567



static.oras.com/manual/2227F



static.oras.com/manual/2216F

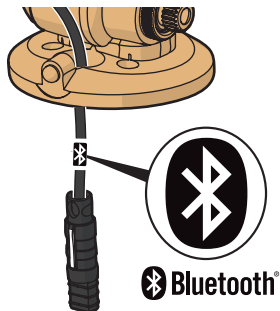

Oras App



apps.oras.com



apps.oras.com

Apple and the Apple logo are trademarks of Apple Inc., registered in the U.S. and other countries. App Store is a service mark of Apple Inc., registered in the U.S. and other countries.

Google Play and the Google Play logo are trademarks of Google Inc.

The Bluetooth® word mark and logos are registered trademarks owned by the Bluetooth SIG, Inc. and any use of such marks by Oras Group is under license. Other trademarks and trade names are those of their respective owners.